

PRODUCT ID: 30947

Switch

MODEL

DG33 SPDT/12VDC

DIMENSIONS

4.5" H x 4.5" W x 1" D (est. 1 lbs)

CONSTRUCTION

Finish: Switch plate brushed stainless steel

Switch: Switch with pre-wired pigtails and indicator lights

Switch plate: Stamped stainless steel pre-punched for switch(es) and indicator light(s)

ELECTRICAL

Input Voltage: 12VDC

Product View

NOTE: Sign image may not exactly represent the finished product. For illustration purposes only.

Front View

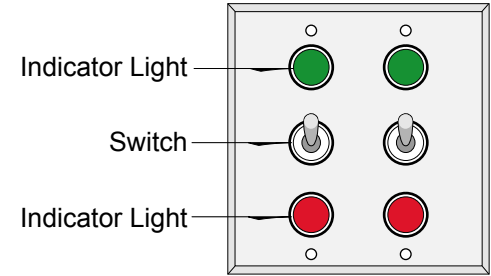

Double Gang

Schematic View

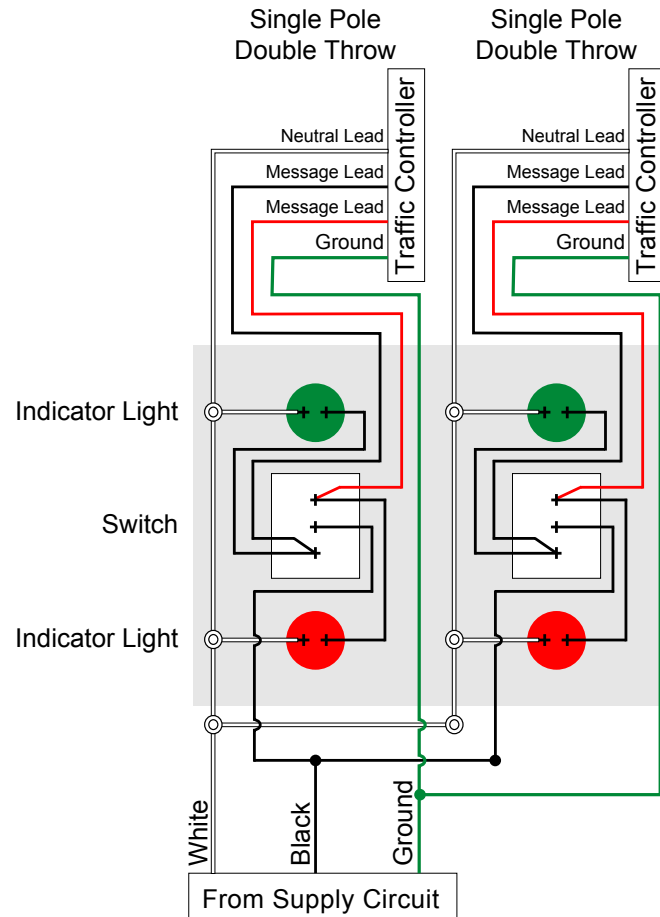

iSIGNS Inc.
7625 Birkmire Drive
Fairview, PA 16415
Phone: 866-437-3040
Website: www.isignsled.com



Proudly Made in the USA